

YOU STAY SAFE
WHEREVER YOU ARE GOING



TURKOMOTIVE
 AFTERMARKET SOLUTIONS

www.turkomotive.com

PLASTIC PROTECTIONS

TURKOMOTIVE AFTERMARKET SOLUTIONS' RELIABLE OE-MATCHING QUALITY COMPONENTS ENSURE
YOU STAY SAFE , WHEREVER YOU ARE GOING



FOLLOW US

#turkomotive

TURKO

YOU STAY SAFE
WHEREVER YOU ARE GOING



www.turkomotive.com

MOTIVE



www.turkomotive.com



YOU STAY SAFE
WHEREVER YOU ARE GOING





SCREW PLUGS

VIDALI TAPALAR



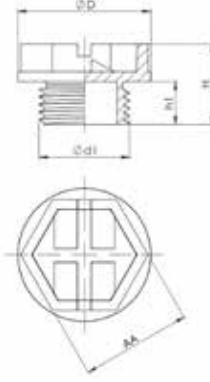

Malzeme / Material :POLIETILEN/POLYTHENE

TURKOMOTIVE KOD / CODE	ÖLÇÜ (mm) / DIMENSIONI (mm)					
	GAZ / GAS	AA	D	d1	H	h1
TM42953	G 1/4 "	16,40	20,90	12,50	16,00	8,50
TM42954	G 3/8 "	15,80	21,30	16,15	16,00	8,50
TM42955	G 1/2 "	21,50	28,90	20,00	19,20	11,20
TM42956	G 3/4 "	24,40	32,30	25,80	17,70	10,50
TM42957	G 1 "	29,50	39,00	32,00	21,30	11,70
TM42958	G1 1/4 "	36,50	48,00	40,10	22,60	13,50
TM42959	G1 1/2 "	41,40	55,00	46,30	22,60	13,00

KOD / CODE	METRİK/METRIC	AA	D	d1	H	h1
TM42960	M12x1.5	15,80	21,30	11,50	15,70	8,50
TM42961	M14x1.5	15,80	21,30	13,50	15,70	8,50
TM42962	M16x1.5	15,80	21,30	15,50	15,70	8,50
TM42963	M18x1.5	21,50	28,90	18,20	19,20	10,90
TM42964	M20x1.5	21,50	28,90	19,40	19,20	11,20
TM42965	M22x1.5	21,50	28,90	21,80	18,00	10,20
TM42966	M24x1.5	21,50	28,90	25,50	18,00	10,20
TM42967	M39x4	36,50	48,00	38,00	30,00	22,00
TM42968	M45x2	41,40	54,80	43,40	22,70	13,00
TM42969	M10x1	15,80	21,30	9,60	14,50	7,20
TM42970	M12x1	15,80	21,30	11,70	14,50	7,20

KOD / CODE	UNF	AA	D	d1	H	h1
TM42971	3/4-16	21,50	28,90	12,60	19,00	11,00

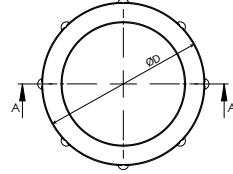
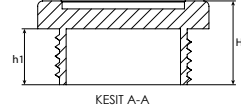

Malzeme / Material :POLİETİLEN/POLYTHENE

TURKOMOTIVE KOD / CODE	ÖLÇÜ (mm) / DIMENSIYONİ (mm)					
	GAZ / GAS	AA	D	d1	H	h1
TM42972	G 1/4 "	-	20,00	12,50	13,50	8,50
TM42973	G 3/8 "	-	20,00	16,00	13,50	8,50
TM42974	G 1/2 "	-	27,50	19,80	16,50	11,20
TM42975	G 3/4 "	-	31,30	25,50	15,30	10,50
TM42976	G 1 "	-	39,00	32,50	18,30	11,70
TM42977	G1 1/4 "	-	48,00	40,10	18,30	13,50
TM42978	G1 1/2 "	-	53,00	46,30	18,30	13,00
KOD / CODE	METRIK/METRIC	AA	D	d1	H	h1
TM42979	M12x1.5	-	20,00	11,50	13,50	8,50
TM42980	M14x1.5	-	20,00	13,50	13,50	8,50
TM42981	M16x1.5	-	20,00	15,50	13,50	8,50
TM42982	M18x1.5	-	27,20	18,20	17,00	10,90
TM42983	M20x1.5	-	28,90	19,40	17,00	11,20
TM42984	M22x1.5	-	28,90	21,80	16,00	10,20
TM42985	M24x1.5	-	28,90	25,50	18,00	10,20
TM42986	M39x4	-	48,00	38,00	30,00	22,00
TM42987	M45x2	-	58,00	43,40	19,00	13,00
TM42988	M10x1	-	20,00	9,60	12,50	7,20
TM42989	M12x1	-	20,00	11,70	12,50	7,20
KOD / CODE	UNF	AA	D	d1	H	h1
TM42990	3/4 - 16	-	27,00	18,90	17,00	11,00

SCREW PLUGS WITH O-RING VIDALI ORINGLI TAPA

PLASTIC
PLUGS

TURKOMOTIVE
AFTERMARKET SOLUTIONS

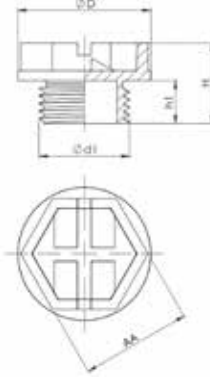

Malzeme / Material :POLIETILEN/POLYTHENE

TURKOMOTIVE KOD / CODE	ÖLÇÜ (mm) / DIMENSIYONİ (mm)					
	GAZ / GAS	AA	D	d1	H	h1
TM42991	G 1/4 "	16,40	20,90	12,50	16,00	8,50
TM42992	G 3/8 "	15,80	21,30	16,15	16,00	8,50
TM42993	G 1/2 "	21,50	28,90	20,00	19,20	11,20
TM42994	G 3/4 "	24,40	32,30	25,80	17,70	10,50
TM42995	G 1 "	29,50	39,00	32,00	21,30	11,70
TM42996	G1 1/4 "	36,50	48,00	40,10	22,60	13,50
TM42997	G1 1/2 "	41,40	55,00	46,30	22,60	13,00

KOD / CODE	METRIK/METRIC	AA	D	d1	H	h1
TM42998	M12x1.5	15,80	21,30	11,50	15,70	8,50
TM42999	M14x1.5	15,80	21,30	13,50	15,70	8,50
TM43000	M16x1.5	15,80	21,30	15,50	15,70	8,50
TM43001	M18x1.5	21,50	28,90	18,20	19,20	10,90
TM43002	M20x1.5	21,50	28,90	19,40	19,20	11,20
TM43003	M22x1.5	21,50	28,90	21,80	18,00	10,20
TM43004	M24x1,5	21,50	28,90	25,50	18,00	10,20
TM43005	M39X4	36,50	48,00	38,00	30,00	22,00
TM43006	M45X2	41,40	54,80	43,40	22,70	13,00
TM43007	M10X1	15,80	21,30	9,60	14,50	7,20
TM43008	M12X1	15,80	21,30	11,70	14,50	7,20

KOD / CODE	UNF	AA	D	d1	H	h1
TM43009	3/4-16	21,50	28,90	18,90	19,00	11,00

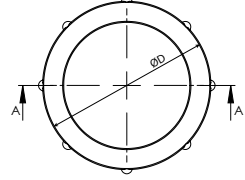
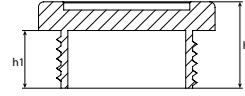

Malzeme / Material :POLİETİLEN/POLYTHENE

TURKOMOTIVE KOD / CODE	ÖLÇÜ (mm) / DIMENSIONI (mm)					
	GAZ / GAS	AA	D	d1	H	h1
TM43010	G 1/4 "	-	20,00	12,50	13,50	8,50
TM43011	G 3/8 "	-	20,00	16,00	13,50	8,50
TM43012	G 1/2 "	-	27,50	19,80	16,50	11,20
TM43013	G 3/4 "	-	31,30	25,50	15,30	10,50
TM43014	G 1 "	-	39,00	32,50	18,30	11,70
TM43015	G1 1/4 "	-	48,00	40,10	18,30	13,50
TM43016	G1 1/2 "	-	53,00	46,30	18,30	13,00
KOD / CODE	METRIK/METRIC	AA	D	d1	H	h1
TM43017	M12x1.5	-	20,00	11,50	13,50	8,50
TM43018	M14x1.5	-	20,00	13,50	13,50	8,50
TM43019	M16x1.5	-	20,00	15,50	13,50	8,50
TM43020	M18x1.5	-	27,20	18,20	17,00	10,90
TM43021	M20x1.5	-	28,90	19,40	17,00	11,20
TM43022	M22x1.5	-	28,90	21,80	16,00	10,20
TM43023	M24x1.5	-	28,90	25,50	18,00	10,20
TM43024	M39x4	-	48,00	38,00	30,00	22,00
TM43025	M45x2	-	58,00	43,40	19,00	13,00
TM43026	M10x1	-	20,00	9,60	12,50	7,20
TM43027	M12x1	-	20,00	11,70	12,50	7,20
KOD / CODE	UNF	AA	D	d1	H	h1
TM43028	3/4 - 16	-	27,00	18,90	17,00	11,00

SCREW PLUGS PARÇA VİDALI TAPA

PLASTIC
PLUGS

TURKOMOTIVE
AFTERMARKET SOLUTIONS



Malzeme / Material : POLİETİLEN/POLYTHENE

TURKOMOTIVE KOD / CODE	ÖLÇÜ (mm) / DIMENSIYONİ (mm)					
	GAZ / GAS	AA	D	d1	H	h1
TM43029	G 1/4 "	-	18,60	12,90	14,20	9,30
TM43030	G 3/8 "	-	21,20	15,90	14,80	9,80
TM43031	G 1/2 "	-	26,50	20,00	15,80	9,80
TM43032	G 5/8 "	-	26,50	22,50	17,50	11,50
TM43033	G 3/4 "	-	31,70	26,00	17,00	10,80
TM43034	G 1 "	-	39,00	31,80	16,30	11,30
TM43035	G1 1/4 "	-	49,00	40,70	17,30	12,30
TM43036	G1 1/2 "	-	53,00	47,70	19,00	13,50

SCREW PLUGS ANAHTAR BAŞLI PARÇA VİDALI TAPA

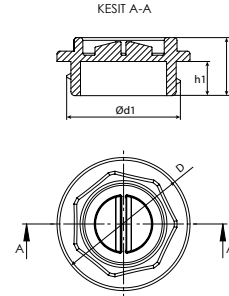

Malzeme / Material : POLİETİLEN/POLYTHENE

TURKOMOTIVE KOD / CODE	ÖLÇÜ (mm) / DIMENSIYONİ (mm)					
	GAZ / GAS	AA	D	d1	H	h1
TM43037	G 1 "	-	39,20	32,20	20,00	11,50
TM43038	G1 1/4 "	-	48,50	41,00	21,00	12,00
TM43039	G1 1/2 "	-	53,60	47,40	22,50	14,00



Malzeme / Material :POLIETİLEN/POLYTHENE

TURKOMOTIVE KOD / CODE	METRİK/METRIC	AA	ÖLÇÜ (mm) / DIMENSIONI (mm)			
			D	d1	H	h1
TM43040	M14	-	24,00	M14	17,50	7,50
TM43041	M16	-	24,00	M16	17,50	7,50

SCREW PLUGS
PARÇA VİDALI TAPA



Malzeme / Material :POLIETİLEN/POLYTHENE

TURKOMOTIVE KOD / CODE	METRİK/METRIC	AA	ÖLÇÜ (mm) / DIMENSIONI (mm)			
			D	d1	H	h1
TM43042	M14	-	24,00	M14	17,50	7,50
TM43043	M16	-	24,00	M16	17,50	7,50

SLOTTED - THREADED PLUG YARIKLI TAPA

PLASTIC
PLUGS

TURKOMOTIVE
AFTERMARKET SOLUTIONS

PLASTIC PLUG

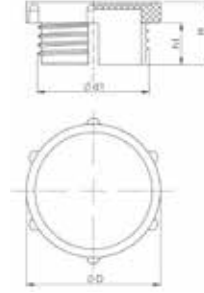

Malzeme / Material : POLIETILEN / POLYTHENE

TURKOMOTIVE KOD / CODE	METRİK/METRIC	AA	ÖLÇÜ (mm) / DIMENSIONI (mm)			
			D	d1	H	h1
TM43044	M18x1,5	-	24,20	17,50	15,00	10,00

SCREW PLUGS MAŞON TAPASI

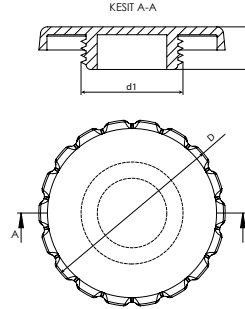

Malzeme / Material : POLIETILEN / POLYTHENE

TURKOMOTIVE KOD / CODE	METRİK/METRIC	MODEL	ÖLÇÜ (mm) / DIMENSIONI (mm)			
			D	d1	L	H
TM43045	M22x1,5	PARÇA VIDALI	40,00	21,80	-	9,50
TM43046	M22x1,5	VIDALI	40,00	21,80	-	9,50

IN-HOLE PLUGS

DELİK İÇİ TAPALAR



TAPARED PLUGS DELİK İÇİ YUMUŞAK TAPA

PLASTIC
PLUGS

TURKOMOTIVE
AFTERMARKET SOLUTIONS

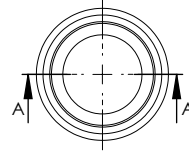
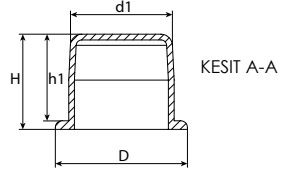

Malzeme / Material :PVC

TURKOMOTIVE KOD / CODE	ÖLÇÜ (mm) / DIMENSIONI (mm)					
	GAZ / GAS	AA	D	d1	H	h1
TM43047	G 1/8 "	-	11,80	8,90	6,00	5,00
TM43048	G 1/4 "	-	14,00	11,90	10,50	9,00
TM43049	G 3/8 "	-	18,50	15,40	10,20	9,00
TM43050	G 1/2 "	-	22,00	19,10	13,80	12,00
TM43051	G 3/4 "	-	28,00	24,80	13,80	13,00
TM43052	G 1 "	-	36,50	30,70	16,00	14,00
TM43053	G1 1/4 "	-	48,00	39,70	16,00	14,00
TM43054	G1 1/2 "	-	52,00	45,50	17,00	15,00
KOD / CODE	METRİK/METRIC	AA	D	d1	H	h1
TM43055	M10x1,5	-	11,80	8,70	4,50	5,70
KOD / CODE	MM	AA	D	d1	H	h1
TM43056	9,00	-	15,80	9,00	9,00	7,00
TM43057	13,50	-	16,00	13,50	10,40	9,40
TM43058	15,40	-	19,20	15,40	12,50	11,50
TM43059	17,50	-	20,00	17,50	15,50	14,50
TM43060	19,00	-	22,00	19,00	12,30	11,50
TM43061	21,50	-	26,00	21,50	17,00	15,50
TM43062	27,70	-	32,50	27,70	19,30	18,00
TM43063	33,10	-	38,80	33,10	10,50	8,50

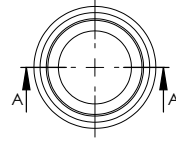
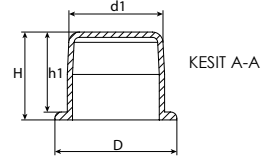

Malzeme / Material : POLIETİLEN/POLYTHENE

TURKOMOTIVE KOD / CODE	ÖLÇÜ (mm) / DIMENSIONI (mm)					
	GAZ / GAS	AA	D	d1	H	h1
TM43064	G 3/8 "	-	18,50	15,40	10,20	9,00
TM43065	G 1/2 "	-	22,50	19,10	13,80	12,00
TM43066	G 3/4 "	-	28,00	24,80	13,80	13,00
TM43067	G 1 "	-	36,50	30,70	16,00	14,00
TM43068	G1 1/4 "	-	48,00	39,70	16,00	14,00
TM43069	G1 1/2 "	-	52,00	45,50	17,00	15,00
KOD / CODE	MM	AA	D	d1	H	h1
TM43070	12,20	-	15,80	12,20	11,00	10,00
TM43071	15,40	-	19,20	15,40	12,30	11,50
TM43072	17,90	-	23,20	17,90	12,00	10,00
TM43073	20,00	-	24,00	20,00	16,50	14,50
TM43074	20,20	-	29,00	20,20	14,00	12,00
TM43075	21,50	-	25,00	21,50	15,20	14,00
TM43076	24,30	-	26,00	24,30	11,50	10,00
TM43077	26,80	-	33,50	26,80	23,00	21,00
TM43078	27,70	-	32,50	27,70	20,40	19,60
TM43079	30,50	-	36,50	30,50	16,00	14,00
TM43080	33,10	-	38,80	33,10	10,50	8,50
TM43081	34,40	-	38,50	34,40	22,20	20,00
TM43082	22,00	-	24,50	22,00	15,00	14,00
TM43083	9,00	-	15,80	9,00	9,00	7,00

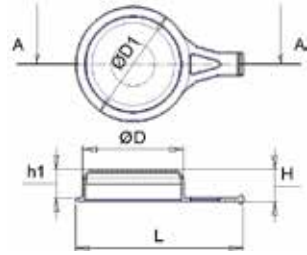

Malzeme / Material :POLIETILEN/POLYTHENE

TURKOMOTIVE KOD / CODE	METRİK/METRIC	ÖLÇÜ (mm) / DIMENSIONI (mm)				
		L	D	d1	H	h1
TM43084	M28	50,00	31,00	26,50	11,00	10,00
TM43085	M36	58,00	40,00	34,50	11,00	10,00

TURKOMOTIVE KOD / CODE	MM	ÖLÇÜ (mm) / DIMENSIONI (mm)				
		L	D	d1	H	h1
TM43086	18,90	30,00	24,00	18,90	12,00	10,50
TM43087	27,80	38,00	34,00	27,80	13,00	11,50

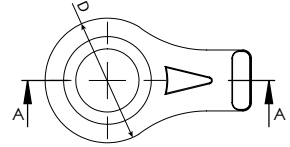
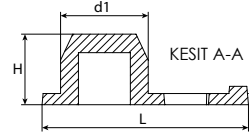

Malzeme / Material :PVC

TURKOMOTIVE KOD / CODE	ÖLÇÜ (mm) / DIMENSIONI (mm)					
	GAZ / GAS	AA	D	d1	L	H
TM43088	G 1/8 "	-	17,00	9,50	27,00	8,50
TM43089	G 1/4 "	-	16,00	11,80	27,00	9,50
KOD / CODE	METRİK/METRIC	AA	D	d1	L	H
TM43090	M10x1,5	-	17,00	9,00	27,00	8,50
KOD / CODE	MM	AA	D	d1	L	H
TM43091	4,00	-	9,00	4,00	11,00	6,50
TM43092	9,90	-	17,00	9,90	27,00	8,50

BARREL PLUGS BOMBELİ TAPA

PLASTIC
PLUGS

TURKOMOTIVE
AFTERMARKET SOLUTIONS

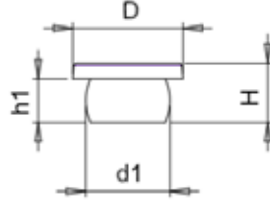

Malzeme / Material :POLIETILEN/POLYTHENE

TURKOMOTIVE KOD / CODE	ÖLÇÜ (mm) / DIMENSIONI (mm)					
	MM	AA	D	d1	H	h1
TM43093	11,00	-	13,90	11,00	7,80	5,60

ROUND TUBE PLUGS KANALLI KOR TAPA

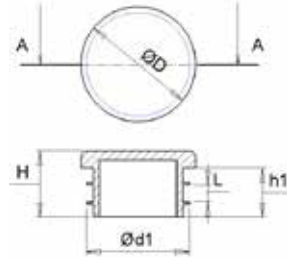

Malzeme / Material :POLIETILEN/POLYTHENE

TURKOMOTIVE KOD / CODE	ÖLÇÜ (mm) / DIMENSIONI (mm)					
	MM	D	d1	L	H	h1
TM43094	10,00	16,00	10,00	2,00	9,00	7,50
TM43095	10,00	11,00	10,00	2,00	9,00	7,50
TM43096	16,00	22,00	15,70	3,00	14,50	13,00
TM43097	18,00	20,00	18,00	2,70	11,00	8,00
TM43098	20,00	21,50	20,00	1,70	13,50	10,50
TM43099	25,00	26,00	25,00	1,80	13,50	9,50

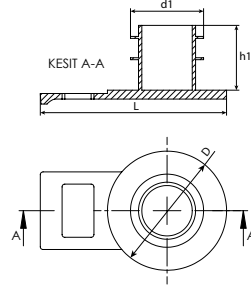

Malzeme / Material :POLIETİLEN/POLYTHENE

TURKOMOTIVE KOD / CODE	ÖLÇÜ (mm) / DIMENSIONI (mm)					
	GAZ / GAS	AA	D	d1	L	H
TM43100	G 1/4 "		22,00	13,00	33,00	12,00
KOD / CODE	METRİK/METRIC	AA	D	d1	L	H
TM43101	M14x1,5	-	22,00	13,00	33,00	12,00
TM43102	M16x1,5	-	22,00	15,70	33,00	13,00
TM43103	M22x1,5	-	27,40	21,40	39,00	13,00

BLIND PLUG

KANALLI KÖR TAPA

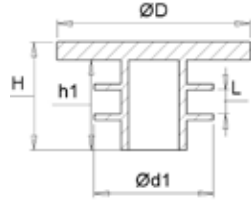

Malzeme / Material :POLIETİLEN/POLYTHENE

TURKOMOTIVE KOD / CODE	ÖLÇÜ (mm) / DIMENSIONI (mm)					
	GAZ / GAS	D	d1	L	H	h1
TM43104	G 1/4 "	22,00	13,00	2,00	10,00	9,00
KOD / CODE	METRİK/METRIC	D	d1	L	H	h1
TM43105	M14x1,5	22,00	13,00	3,00	14,50	13,00
TM43106	M16x1,5	22,00	15,70	3,00	14,50	13,00

PULL PLUGS DIK SAPLI KANALLI TAPA

PLASTIC
PLUGS

TURKOMOTIVE
AFTERMARKET SOLUTIONS

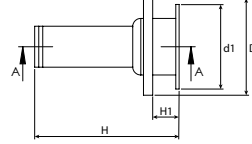
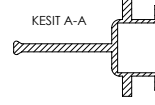

Malzeme / Material :POLIETILEN/POLYTHENE

TURKOMOTIVE KOD / CODE	METRİK/METRIC	AA	ÖLÇÜ (mm) / DIMENSIONI (mm)			
			D	d1	H	h1
TM43107	M12x1,5	-	13,70	11,70	26,50	4,00
TM43108	M14x1,5	-	15,80	13,40	26,50	4,00
TM43109	M16x1,5	-	18,00	15,70	26,50	4,00
TM43110	M18x1,5	-	22,00	17,80	26,50	4,00

BLIND PLUG KOR TAPA

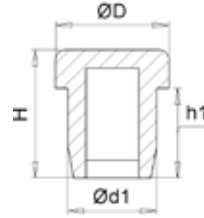

Malzeme / Material :POLIETILEN/POLYTHENE

TURKOMOTIVE KOD / CODE	METRİK/METRIC	AA	ÖLÇÜ (mm) / DIMENSIONI (mm)			
			D	d1	H	h1
TM43111	M8	-	9,00	6,90	10,00	7,00
KOD / CODE	MM	AA	D	d1	H	h1
TM43112	4,50	-	6,50	4,50	6,00	5,20
TM43113	5,50	-	11,00	5,50	9,00	7,50

PROTECTIVE CAPS

DIŞ ÜSTÜ KAPAKLAR



plastic protections



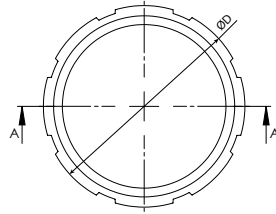
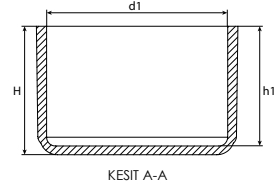

Malzeme / Material :PVC

TURKOMOTIVE KOD / CODE	ÖLÇÜ (mm) / DIMENSIONI (mm)					
	GAZ / GAS	AA	D	d1	H	h1
TM43114	G 3/8 "	-	19,00	16,50	21,00	20,00
TM43115	G 1/2 "	-	23,00	20,50	21,00	20,00
TM43116	G 1 "	-	36,00	32,00	22,00	20,00
KOD / CODE	METRİK/METRIC	AA	D	d1	H	h1
TM43117	M14x1,5	-	16,70	13,70	22,00	21,00
TM43118	M22x1,5	-	23,00	20,50	21,00	20,00
KOD / CODE	MM	AA	D	d1	H	h1
TM43119	31,00	-	34,00	31,00	22,00	20,00
TM43120	37,50	-	39,00	36,00	22,00	20,00

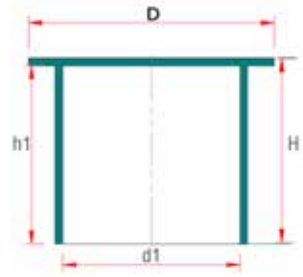

Malzeme / Material : POLIETİLEN/POLYTHENE

TURKOMOTIVE KOD / CODE	ÖLÇÜ (mm) / DIMENSIYON (mm)					
	METRİK/METRIC	AA	D	d1	H	h1
TM43121	M6	-	14,00	5,80	30,00	29,00
KOD / CODE	MM	AA	D	d1	H	h1
TM43122	6,50	-	14,00	6,50	30,00	29,00
TM43123	7,60	-	13,50	7,60	16,00	15,00
TM43124	8,00	-	14,00	7,80	30,00	29,00
TM43125	8,00	-	15,00	7,80	74,00	73,00
TM43126	9,00	-	15,00	9,00	16,00	15,00
TM43127	22,00	-	29,00	22,00	35,00	32,00
TM43128	26,00	-	33,00	26,00	45,00	42,00
TM43129	30,00	-	39,50	30,00	60,00	57,00

FLAT CAPS DIŐ ÜSTÜ KAPAK

PLASTIC
PLUGS

TURKOMOTIVE
AFTERMARKET SOLUTIONS

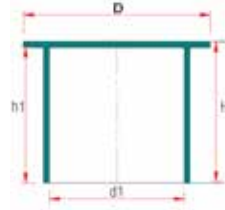

Malzeme / Material : POLIETILEN / POLYTHENE

TURKOMOTIVE KOD / CODE	ÖLÇÜ (mm) / DIMENSIONI (mm)					
	MM	AA	D	d	H	h1
TM43130	24,00	-	26,50	24,00	23,50	21,00
TM43131	26,50	-	32,50	26,50	23,50	22,00
TM43132	32,00	-	35,50	32,00	23,50	22,00
TM43133	40,00	-	44,00	40,00	30,50	29,00
TM43134	21,80	-	24,50	21,80	20,00	18,00
TM43135	48,50	-	57,00	48,50	12,00	10,00
TM43136	54,50	-	60,00	54,50	23,00	21,00

HEX CAPS ALTIGEN KAPAK

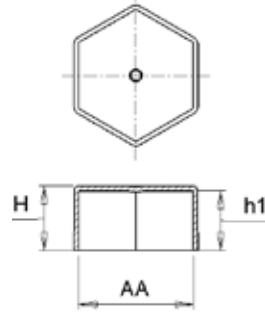

Malzeme / Material : POLIETILEN / POLYTHENE

TURKOMOTIVE KOD / CODE	ÖLÇÜ (mm) / DIMENSIONI (mm)					
	WHITWORTH	AA	D	d1	H	h1
TM43137	-	31,50x31,50	-	-	17,80	16,00

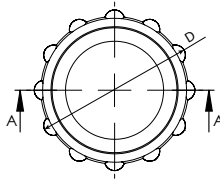
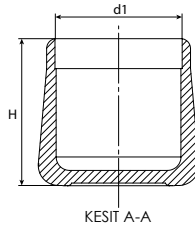

Malzeme / Material :PVC

TURKOMOTIVE KOD / CODE	ÖLÇÜ (mm) / DIMENSIONI (mm)					
	WHITWORTH	AA	D	d1	H	h1
TM43138	W9/16	-	18,70	13,50	20,00	18,50
TM43139	W5/8	-	21,50	15,50	23,50	22,00
TM43140	W3/4	-	23,80	18,30	21,80	20,00

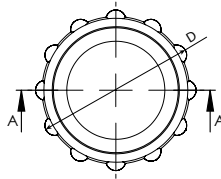
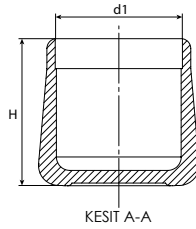

Malzeme / Material : POLETİLEN / POLYTHENE

TURKOMOTIVE KOD / CODE	ÖLÇÜ (mm) / DIMENSIONI (mm)					
	WHITWORTH	AA	D	d1	H	h1
TM43141	W9/16	-	18,70	13,50	20,00	18,50
TM43142	W5/8	-	21,50	15,50	23,50	22,00
TM43143	W3/4	-	23,80	18,30	21,80	20,00

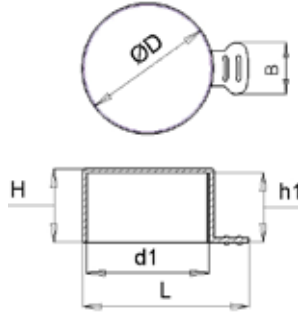

Malzeme / Material : POLIETİLEN/POLYTHENE

TURKOMOTIVE KOD / CODE	ÖLÇÜ (mm) / DIMENSIONI (mm)						
	GAZ / GAS	L	D	d1	H	h1	B
TM43144	G1/4	21,80	14,60	13,30	13,00	12,00	12,00
TM43145	G3/8	27,40	18,40	16,80	13,00	12,00	14,00
TM43146	G3/4	38,20	28,40	26,40	16,80	15,80	14,00
TM43147	G1	45,00	35,50	33,25	21,00	19,00	14,00

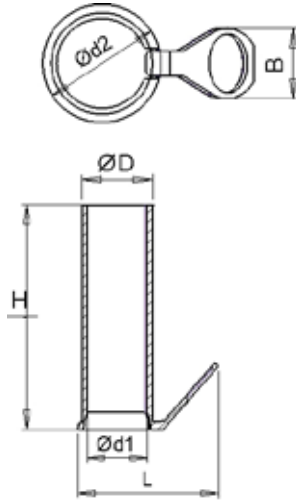

Malzeme / Material : POLETILEN/POLYTHENE

TURKOMOTIVE KOD / CODE	ÖLÇÜ (mm) / DIMENSIONI (mm)						
	MM	L	D	d1	d2	H	B
TM43148	32	74,50	37,80	32,00	42,00	120,00	25,00

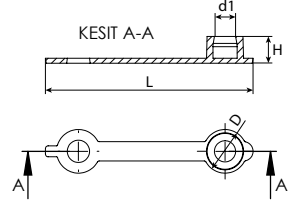

Malzeme / Material : POLIETİLEN/POLYTHENE

TURKOMOTIVE KOD / CODE	METRİK/METRIC	AA	ÖLÇÜ (mm) / DIMENSIONI (mm)			
			D	d1	L	H
TM43149	M6	-	11,50	M6	55,00	8,00

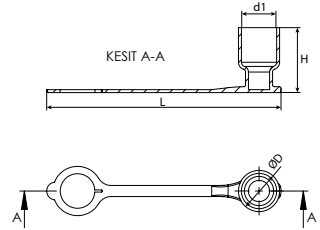

Malzeme / Material : POLIETİLEN/POLYTHENE

TURKOMOTIVE KOD / CODE	MM	d2	ÖLÇÜ (mm) / DIMENSIONI (mm)			
			D	d1	L	H
TM43150	ERKEK	23,00	28,00	24,00	160,00	43,00

PLUGS GLASÖRLÜK TAPASI

PLASTIC
PLUGS

TURKOMOTIVE
AFTERMARKET SOLUTIONS

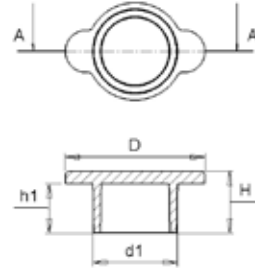

Malzeme / Material : POLIETİLEN/POLYTHENE

TURKOMOTIVE KOD / CODE	METRİK/METRIC	AA	ÖLÇÜ (mm) / DIMENSIYONİ (mm)			
			D	d1	H	h1
TM43151	M6	-	16,50	9,80	8,00	5,80

NUT COVER SOMUN KAPAĞI

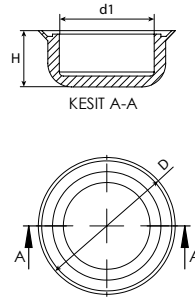

Malzeme / Material : POLIETİLEN/POLYTHENE

TURKOMOTIVE KOD / CODE	METRİK/METRIC	AA	ÖLÇÜ (mm) / DIMENSIYONİ (mm)			
			D	d1	L	H
TM43152	M8	-	20,00	14,00	-	8,50

PLASTIC PLUG

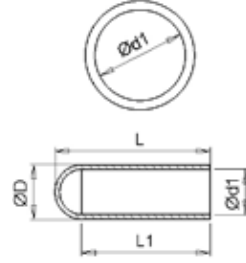

Malzeme / Material : POLIETİLEN / POLYTHENE

TURKOMOTIVE KOD / CODE	GAZ / GAS	AA	ÖLÇÜ (mm) / DIMENSIONI (mm)			
			D	d1	H	h1
TM43153	G3/8		19,00	16,00	21,00	20,00

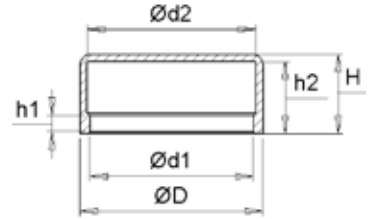

Malzeme / Material : POLIETİLEN / POLYTHENE

TURKOMOTIVE KOD / CODE	MM	D	ÖLÇÜ (mm) / DIMENSIONI (mm)				
			d1	d2	h1	h2	H
TM43154	22,50	25,40	22,50	23,40	2,20	10,00	11,00

PROTECTIVE COVER DIŐ ÜSTÜ KAPAK

PLASTIC
PLUGS

TURKOMOTIVE
AFTERMARKET SOLUTIONS

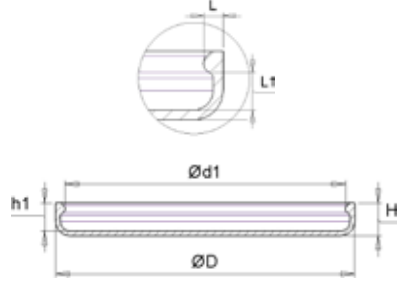

Malzeme / Material :POLIETILEN / POLYTHENE

TURKOMOTIVE KOD / CODE	ÖLÇÜ (mm) / DIMENSIONI (mm)						
	MM	D	d1	h1	H	L	L1
TM43155	121,50	129,50	121,50	12,00	14,00	4,00	7,50

PROTECTIVE PLUGS DIŐ ÜSTÜ KULAKLI YUMUŐAK TAPA

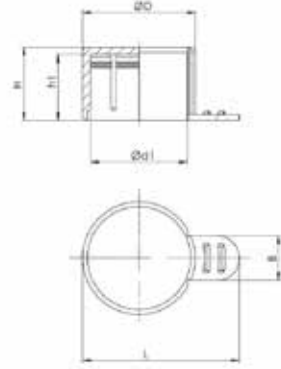

Malzeme / Material :PVC

TURKOMOTIVE KOD / CODE	ÖLÇÜ (mm) / DIMENSIONI (mm)					
	METRİK/METRIC	AA	D	d1	L	H
TM43156	M12x1,5	15,00	11,80	21,00	12,00	13,00
TM43157	M18x1,5	19,80	17,50	27,50	14,50	15,80
TM43158	M24x1,5	27,00	23,80	42,00	13,00	11,00

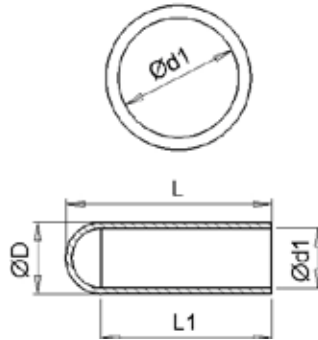

Malzeme / Material :PVC

TURKOMOTIVE KOD / CODE	METRİK/METRIC	AA	ÖLÇÜ (mm) / DIMENSIYONİ (mm)			
			d1	D	L1	L
TM43159	M14	-	13,70	16,50	39,00	47,00

HORN CAP BOYNUZ TAPASI

PLASTIC
PLUGS

TURKOMOTIVE
AFTERMARKET SOLUTIONS

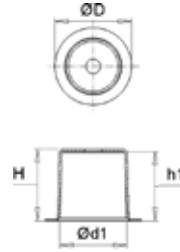

Malzeme / Material :POLIETILEN/POLYTHENE

TURKOMOTIVE KOD / CODE	ÖLÇÜ (mm) / DIMENSIONI (mm)					
	MM	AA	D	d1	H	h1
TM43160	60,00	-	87,50	60,00	65,30	63,30

HORN CAP BOYNUZ TAPASI

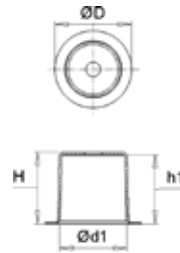

Malzeme / Material :PVC

TURKOMOTIVE KOD / CODE	ÖLÇÜ (mm) / DIMENSIONI (mm)					
	MM	AA	D	d1	H	h1
TM43161	60,00	-	87,50	60,00	65,30	63,30

SPECIAL PRODUCTS

ÖZEL ÜRÜNLER



HYDRAULIC ARM KUMANDA KOLU

PLASTIC
PLUGS

TURKOMOTIVE
AFTERMARKET SOLUTIONS

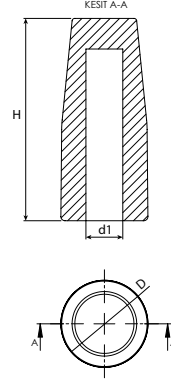

Malzeme / Material :PP

TURKOMOTIVE KOD / CODE	METRİK/METRIC	AA	ÖLÇÜ (mm) / DIMENSIYONİ (mm)			
			D	d1	L	H
TM43162	M8	-	20,50	M8	185,00	137,00
TM43163	M10	-	20,50	M10	185,00	137,00

HYDRAULIC ARM PLASTIC KUMANDA KOLU PLASTİĞİ

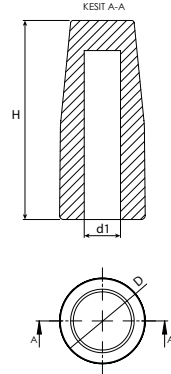

Malzeme / Material :PP

TURKOMOTIVE KOD / CODE	METRİK/METRIC	AA	ÖLÇÜ (mm) / DIMENSIYONİ (mm)			
			D	d1	L	H
TM43164	M8	-	20,50	M8	-	48,00
TM43165	M10	-	20,50	M10	-	48,00



KESİT A-A

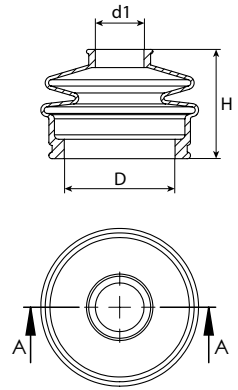

Malzeme / Material : PVC

TURKOMOTIVE KOD / CODE	BOĞUM/RING	AA	ÖLÇÜ (mm) / DIMENSIONI (mm)			
			D	d1	L	H
TM43166	1	-	24,00	12,00	-	26,00



KESİT A-A

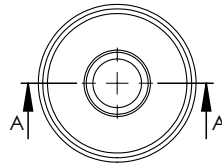
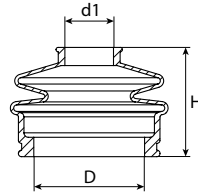

Malzeme / Material : KAUÇUK / RUBBER

TURKOMOTIVE KOD / CODE	BOĞUM/RING	AA	ÖLÇÜ (mm) / DIMENSIONİ (mm)			
			D	d1	L	H
TM43167	2	-	39,00	14,00	-	41,00
TM43168	1	-	35,00	11,00	-	26,00
TM43169	3	-	42,00	16,00	-	48,00
TM43170	2	-	28,50	13,00	-	28,00

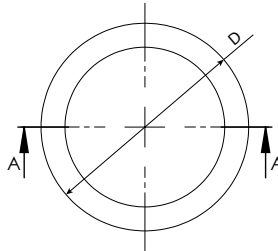
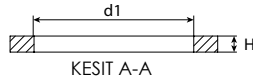

Malzeme / Material : POM

TURKOMOTIVE KOD / CODE	ÖLÇÜ (mm) / DIMENSIONI (mm)					
	GAZ / GAS	AA	D	d1	L	H
TM43171	G 3/8 "	-	29,00	20,00	-	1,90
TM43172	G 1/2 "	-	35,00	25,00	-	2,50
TM43173	G 3/4 "	-	43,00	30,00	-	2,50
TURKOMOTIVE KOD / CODE	ÖLÇÜ (mm) / DIMENSIONI (mm)					
	MM	AA	D	d1	L	H
TM43174	73,50	-	80,90	73,50	-	3,00

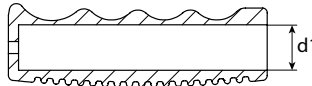
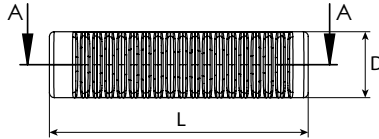

KESIT A-A

Malzeme / Material : TPE

TURKOMOTIVE KOD / CODE	ÖLÇÜ (mm) / DIMENSIONI (mm)					
	MM	AA	D	d1	L	H
TM43175	21,00	-	28,00	21,00	108,00	-

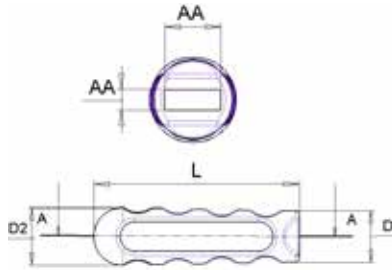

Malzeme / Material : TPE

TURKOMOTIVE KOD / CODE	ÖLÇÜ (mm) / DIMENSIONI (mm)					
	MM	AA	D	D2	L	H
TM43176	-	18x6,50	25,00	27,00	98,00	-

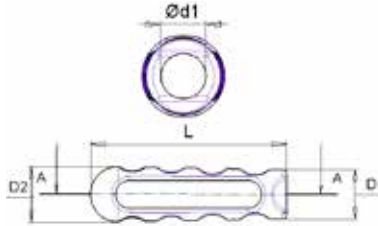

Malzeme / Material : TPE

TURKOMOTIVE KOD / CODE	ÖLÇÜ (mm) / DIMENSIONI (mm)					
	MM	AA	D	d1	L	H
TM43177	15,00	-	25,00	14,80	98,00	-

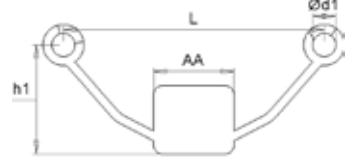

Malzeme / Material : POLIETILEN/POLYTHENE

TURKOMOTIVE KOD / CODE	ÖLÇÜ (mm) / DIMENSIONI (mm)					
	D	AA	d1	L	H	h1
TM43178	-	28x24	8,00	90,00	-	37,50

PROTECTIVE COVER

KASNAK KORUYUCU TAPA

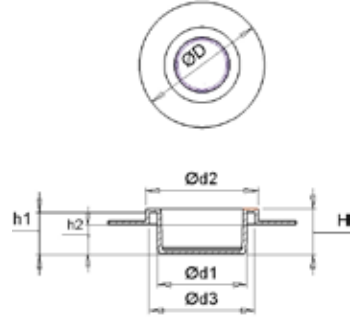

Malzeme / Material : POLIETILEN/POLYTHENE

TURKOMOTIVE KOD / CODE	ÖLÇÜ (mm) / DIMENSIONI (mm)								
	MM	D	d1	d2	d3	h1	h2	H	
TM43179	30,00	63,00	30,10	37,90	35,50	14,00	10,00	15,20	

SQUARE PLUG KARE TAPA

PLASTIC
PLUGS

TURKOMOTIVE
AFTERMARKET SOLUTIONS

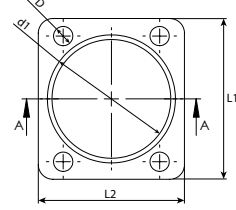

Malzeme / Material :POLIETİLEN/POLYTHENE

TURKOMOTIVE KOD / CODE	ÖLÇÜ (mm) / DIMENSIONI (mm)							
	MM	AA	L1	L2	d1	D	h1	H
TM43180	M8	42x33	55,00	50,00	43,20	6,50	12,00	10,00

SQUARE PLUG KULAKLI KARE ETİKET TAPASI

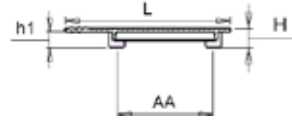
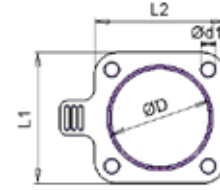

Malzeme / Material :POLIETİLEN/POLYTHENE

TURKOMOTIVE KOD / CODE	ÖLÇÜ (mm) / DIMENSIONI (mm)							
	D	AA	L1	L2	H			h1
TM43181	37x37	37x50	5,50	65,00	50,00	50,00	7,00	8,50
TM43182	42x42	45,00	6,50	75,00	57,00	57,00	7,00	8,50
TM43183	50x50	57x50	6,50	79,00	66,00	64,00	7,00	8,50

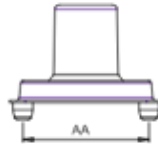
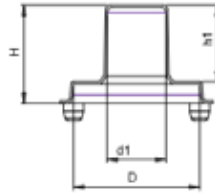

Malzeme / Material :POLIETİLEN/POLYTHENE

TURKOMOTIVE KOD / CODE	ÖLÇÜ (mm) / DIMENSIONI (mm)				
	AA	D	d1	H	h1
TM43184	80x80	80,00	36,00	64,00	48,00

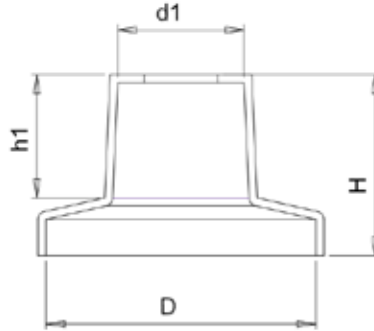

Malzeme / Material :POLIETILEN/POLYTHENE

TURKOMOTIVE KOD / CODE	DIMENSONI	ÖLÇÜ (mm) / DIMENSONI (mm)				
		AA	D	d1	H	h1
TM43185	20,00	-	37,00	15,00	30,00	19,00

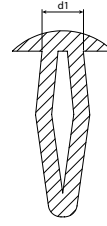

KESİT A-A

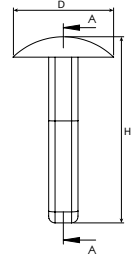

Malzeme / Material : POM

TURKOMOTIVE KOD / CODE	ÖLÇÜ (mm) / DIMENSIONI (mm)					
	MM	d2	D	d1	L	H
TM43186	3,50	4,20	8,00	3,50	-	14,20
TM43187	5,20	6,80	9,00	5,20	-	15,70

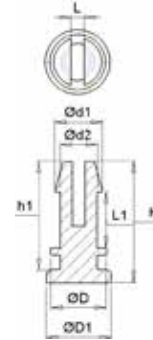

Malzeme / Material : POM

TURKOMOTIVE KOD / CODE	ÖLÇÜ (mm) / DIMENSIONI (mm)								
	MM	D1	D	d1	d2	h1	H	L1	L
TM43188	2,65	3,55	3,05	2,65	2,00	6,00	6,70	3,10	0,70

SENSOR COVER SENSÖR KAPAĞI

PLASTIC
PLUGS

TURKOMOTIVE
AFTERMARKET SOLUTIONS

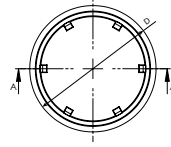
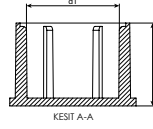

Malzeme / Material :POLİETİLEN/POLYTHENE

TURKOMOTIVE KOD / CODE	ÖLÇÜ (mm) / DIMENSIONI (mm)					
	MM	AA	D	d1	H	h1
TM43189	23,00	-	32,00	23,00	21,00	19,00

VALVE SEAL VENTİL KEÇESİ

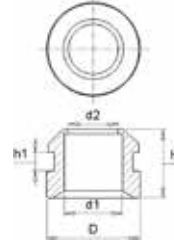

Malzeme / Material :PVC

TURKOMOTIVE KOD / CODE	ÖLÇÜ (mm) / DIMENSIONI (mm)				
	d1	d2	D	h1	H
TM43190	14,00	12,00	22,50	4,50	16,50

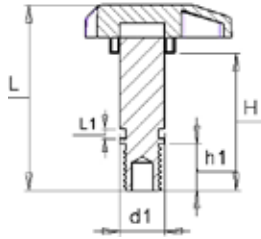

Malzeme / Material : PP

TURKOMOTIVE KOD / CODE	METRIK	ÖLÇÜ (mm) / DIMENSIONI (mm)				
		d1	h1	H	L1	L
TM43191	M12	13,90	14,50	43,00	3,00	60,00

PALLET WEDGE PALET TAKOZU

PLASTIC
PLUGS

TURKOMOTIVE
AFTERMARKET SOLUTIONS



KESIT A-A

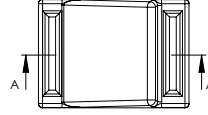
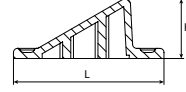

Malzeme / Material : TPE

TURKOMOTIVE KOD / CODE	MODEL	AA	ÖLÇÜ (mm) / DIMENSIONI (mm)			
			D	d1	L	H
TM43192	PALET TAKOZU	-	-	-	56x40	22,00

BRACKET PLUGS BRACKET TAPASI

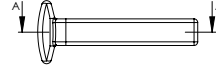

KESIT A-A

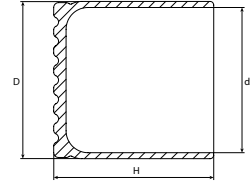

Malzeme / Material : PVC

TURKOMOTIVE KOD / CODE	MODEL	AA	ÖLÇÜ (mm) / DIMENSIONI (mm)			
			D	d1	d2	H
TM43193	BRACKET TAPASI	-	63,00	58,80	6,00	63,00

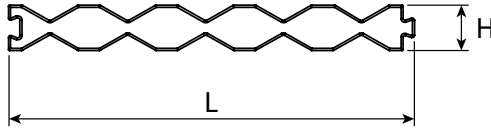

Malzeme / Material : PP

TURKOMOTIVE KOD / CODE	MODEL	AA	ÖLÇÜ (mm) / DIMENSIONI (mm)			
			D	d1	L	H
TM43194	V YATAĞI	-	-	-	580,00	65,00

SHAFT FIXING LİFT V YATAĞI

PLASTIC
PLUGS

TURKOMOTIVE
AFTERMARKET SOLUTIONS

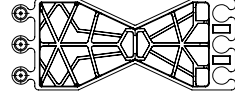

Malzeme / Material : PP

TURKOMOTIVE KOD / CODE	MODEL	ÖLÇÜ (mm) / DIMENSIONI (mm)				
		AA	D	d1	L	H
TM43195	V YATAĞI	-	-	-	-	-

SHAFT FIXING LİFT V YATAĞI

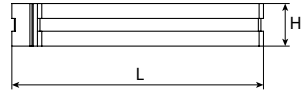
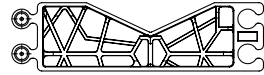

Malzeme / Material : PP

TURKOMOTIVE KOD / CODE	MODEL	ÖLÇÜ (mm) / DIMENSIONI (mm)				
		AA	D	d1	L	H
TM43196	V YATAĞI	-	-	-	-	-

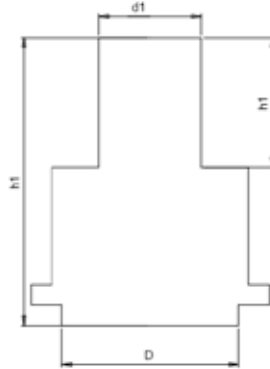
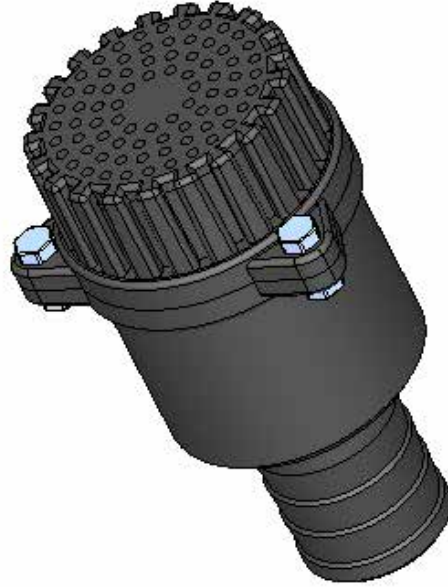

Malzeme / Material : N6 GFR30

TURKOMOTIVE KOD / CODE	DIMENSIYONİ	AA	ÖLÇÜ (mm) / DIMENSIYONİ (mm)			
			D	d1	H	h1
TM43197	2"	-	90,00	52,00	193,00	66,00



PLASTIC
PLUGS



**YOU STAY SAFE
WHEREVER YOU ARE GOING**



**TURKOMOTIVE AFTERMARKET SOLUTIONS' RELIABLE OE-MATCHING QUALITY COMPONENTS ENSURE
YOU STAY MOBILE , WHEREVER YOU ARE GOING**

**FOLLOW
US**

#turkomotive

www.turkomotive.com

